









-  DO_0345 Outer Width = -0 , Height = -5
-  WT Rebated threshold width = -0
-  DSO_0343 Stile width = -67
Stile Height = -43
DD Rail = width / 2 - 37
-  DM_0328 Mid Rail = Top Rail - 144
-  DDA_0323 DD Adaptor = Door stile - 17
(Cut Top @ 4 Deg)
-  BV02 Door Bead (Open In 22952)
-  BV04 Bevel Bead
-  5014 Drip
-  WPC Wool pile Carrier
-  WT001 - Rebated WT Packer

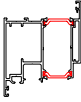
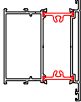
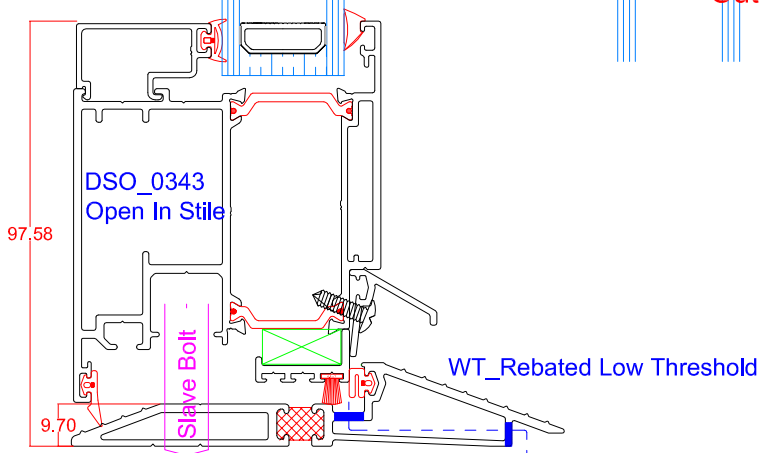

Glass width = -217
 Full Glass Height = -195
 Top Glass = Height - midrail from bottom -147
 Bottom Glass = Mid rail from bottom - 124
 DD Glass Width = Width / 2 - 188